

(PL) Instrukcja montażu
 (D) Aufbauanleitung
 (GB) Assembly instruction
 (SK) Návod na montáž

Łóżko
 Bettgestell
 Bed
 Postel'

80265

(08-10)



materace

M&K foam GmbH Sp z o.o.
 ul. Toruńska 267
 62-600 Kolo
 Tel. 0048 63 2624300
 Fax 0048 63 2616118
 www.mkfoam.pl



E.Kretschmar GmbH & Co KG
 Rudolf - Diesel - Weg 10
 30419 Hannover
 Tel. 0049 511 96605540
 Fax 0049 511 96605599

UWAGA

Drogi kliencie, przed rozpoczęciem montażu upewnij się, czy posiadasz wszystkie niezbędne elementy pokazane na instrukcji.

Bez instrukcji montażu oraz oznaczeń kontrolnych, reklamacja nie będzie uwzględniona.

W przypadku domówienia mebla tapicerowanego tkaniną w takim samym kolorze jak zakupione wcześniej meble, może wystąpić różnica w odcieniach wybranej tkaniny.

ACHTUNG

Sehr geehrter Kunde. Bitte überprüfen Sie vor Beginn der Montage die Vollständigkeit unten aufgeführten Bauteile.

Ohne diese Aufbauanleitung mit Prüfvermerken ist eine Reklamationsbearbeitung nicht möglich.

Bei einer Nachbestellung dieser Artikel können Farbabweichungen bei den gewebten Stoffen sein.

CAUTION

Dear Customer, before assembly, ensure that you have all the necessary elements specified in the instruction.

Your complaint will not be considered without the manual and control marking.

In case of ordering the same fabric in different time, the colour of fabric may be a little bit different.

POZOR

Vážený zákazník, pred montážou sa prosíme uistiť či v balení sú všetky potrebné diely znázornené v návode.

Bez návodu na montáž a kontrolného značenia reklamácia nebude prijatá.

V prípade objednania textilie čalúnený nábytok v rovnakej farbe ako predtým zakúpeného nábytku, môže byť rozdiel v odtieňoch zvolenej látky.

Oznaczenia kontrolne
 Bezeichnungen steuern
 Control marks
 Označenie ovládat'

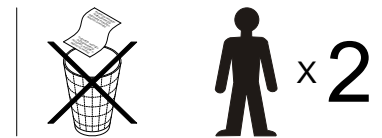

Elementy w paczkach
 Befestigungsmaterial im Paket
 Items in the packages
 Položky v balení



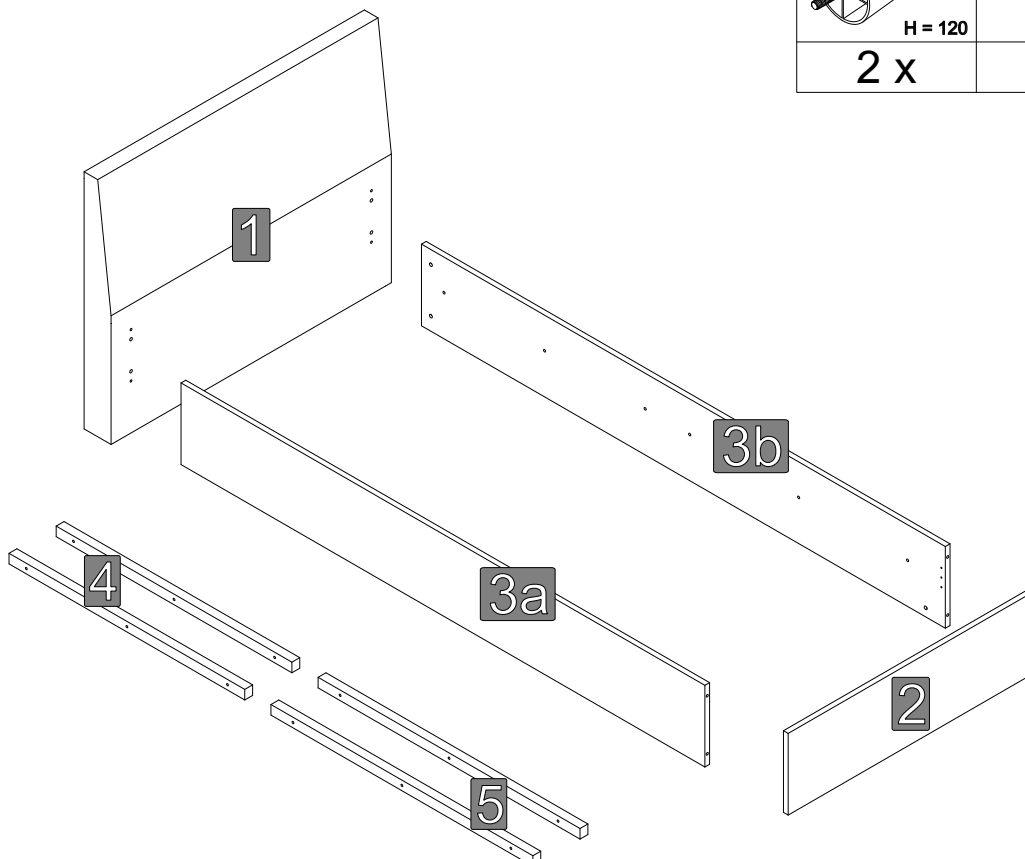

V1	V2	V3
 TW - M 1011 H = 120		
2 x	2 x	1 x





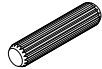
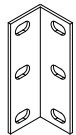

Nr	Indeks	Szt.
1	X-80264-ZG....	1
2	X-80263-ZN....	1
3a	X-80263-BL....	1
3b	X-80263-BP....	1
4	X_LP-900-P2	2
5	X_LP-....-P2	2

Elementy w worku serwisowym
 Befestigungsmaterial im Servicebeutel
 Items in bag service
 Položky v sáčku služby

X_80263-WSM

A	B	C	D	E	F
					
∅ 8 x 35	∅ 10 x 45		6,3 x 16	M8	10 x 13
4 x	4 x	2 x	12 x	2 x	8 x

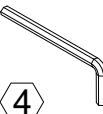
G	H	I	J	K	L
					
M6 x 40	M6 x 45	M6 x 60	4 x 16		
4 x	12 x	4 x	2 x	1 x	1 x

Dodatkowe elementy niezbędne do sprawnego montażu
 Zusätzliche Komponenten für eine reibungslose Installation
 Additional components needed for a smooth assembly
 Ďalšie komponenty potrebné pre správny inštaláciu

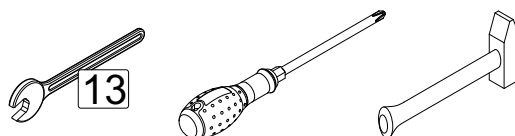

Instrukcja montażu - Aufbauanleitung - Assembly instruction - Návod na montáž

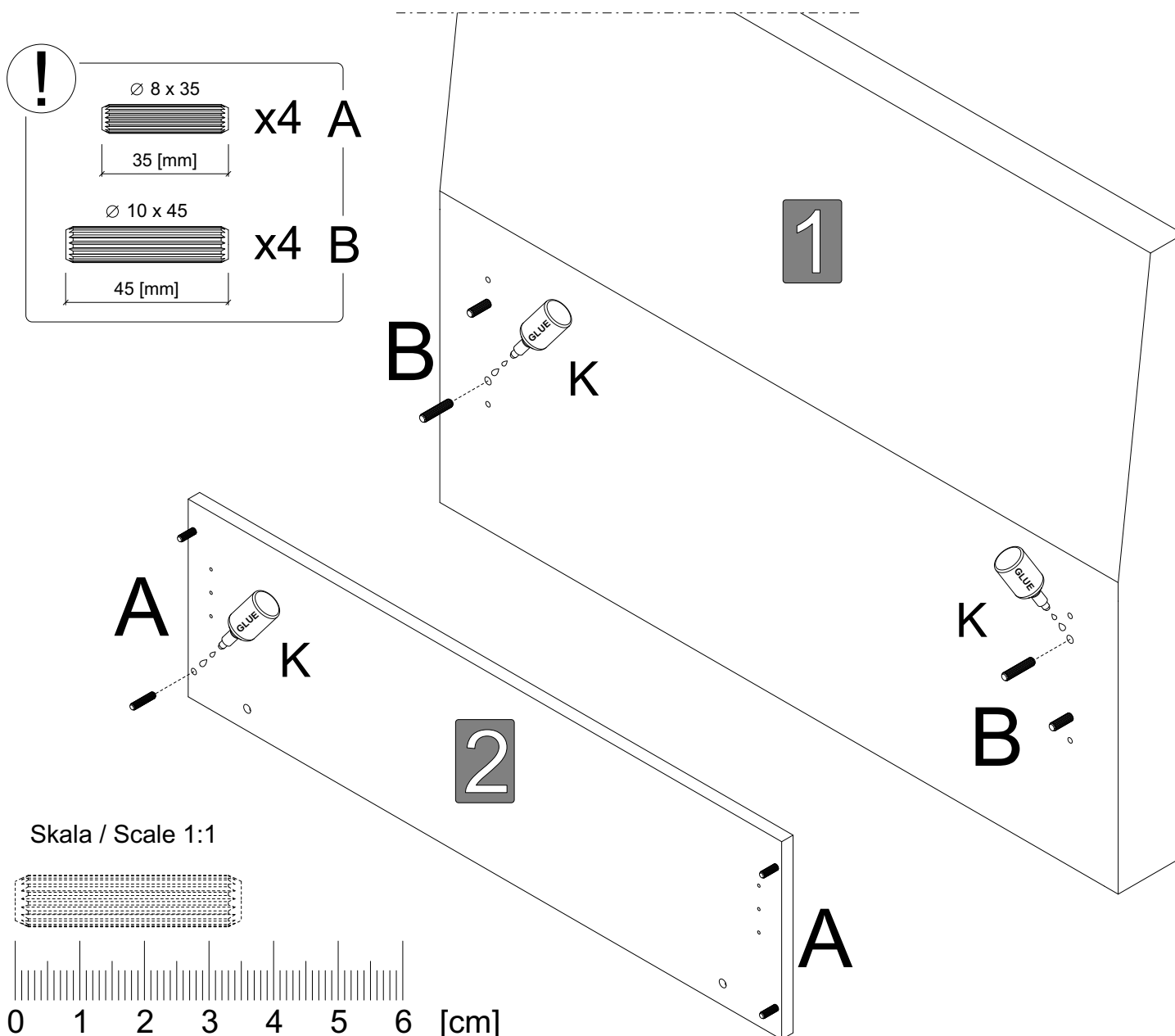

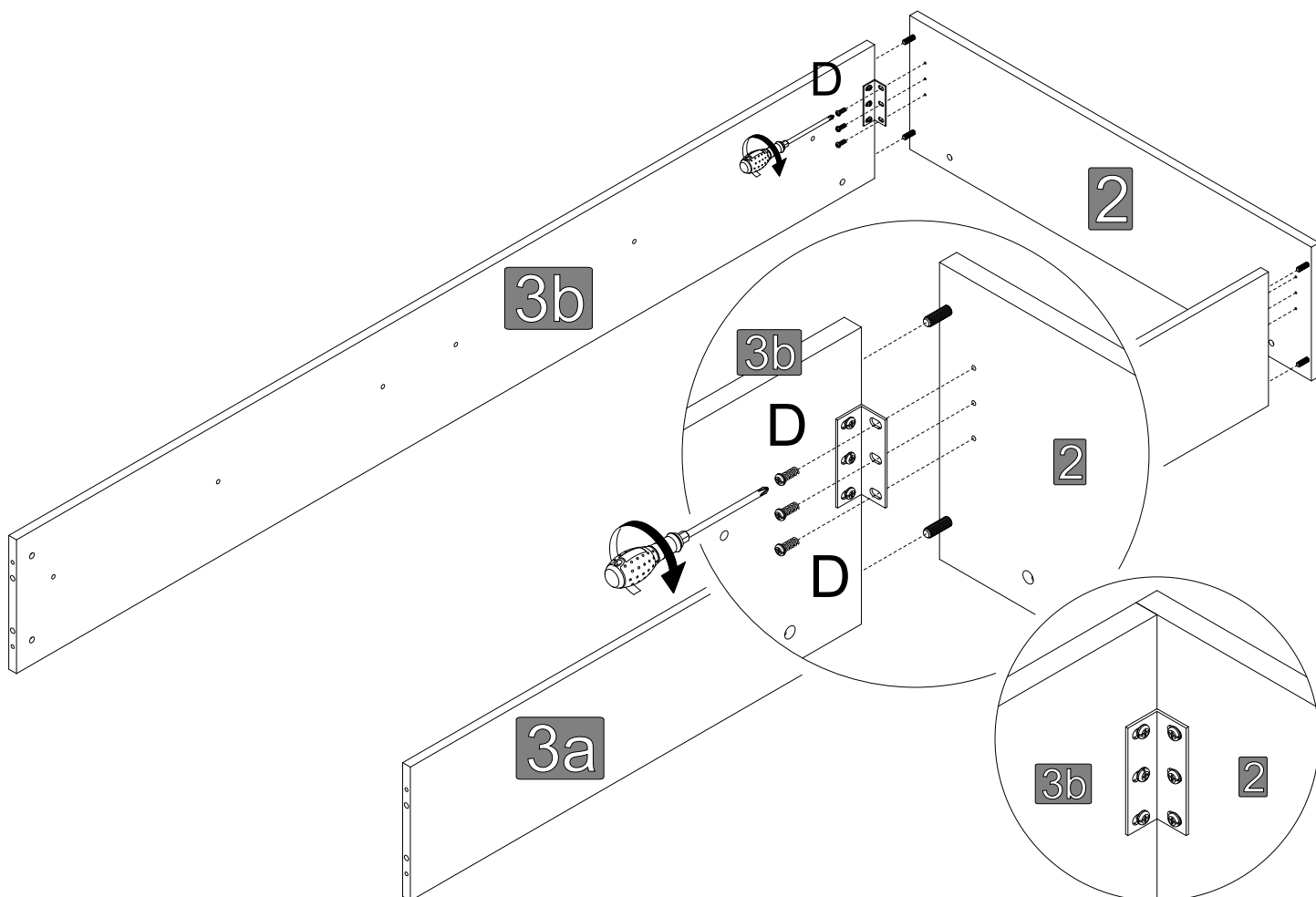
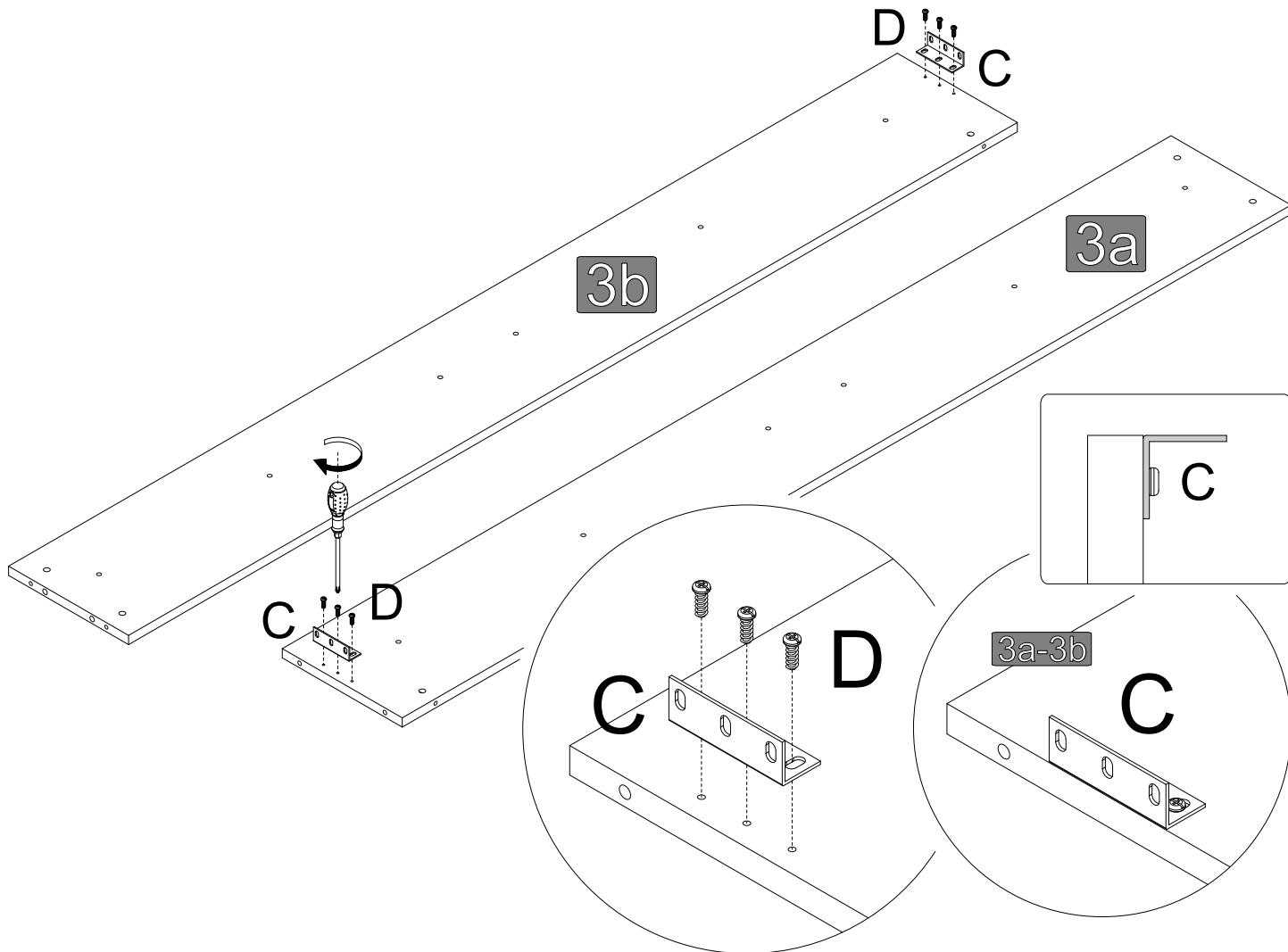

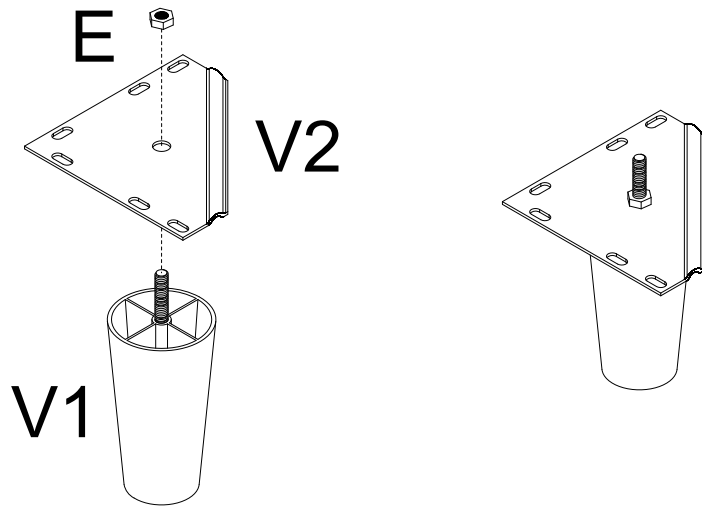

! OSTROŻNIE
VORSICHT
CAUTION
UPOZORNENIE

180°

